

<p>PODER JUDICIAL PROVINCIA DE RIO NEGRO</p>		 <p>PODER JUDICIAL PROVINCIA DE RIO NEGRO</p>
<p>MANTENIMIENTO INMUEBLES VARIOS-EL BOLSON</p>		
<p>PLANO DE: INMUEBLE 1-PLANTA</p>	<p>ESCALA: 1:100</p>	

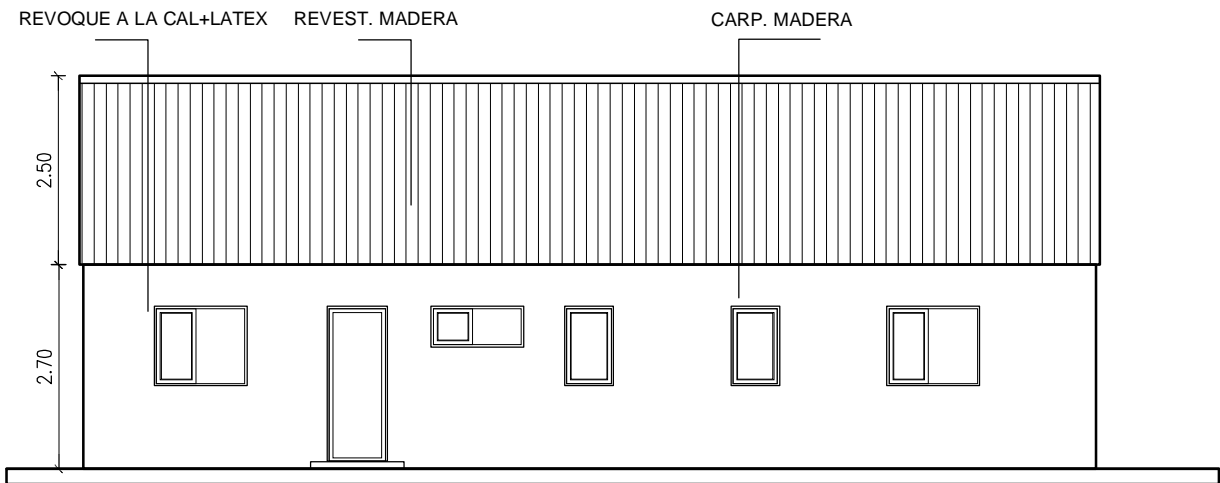
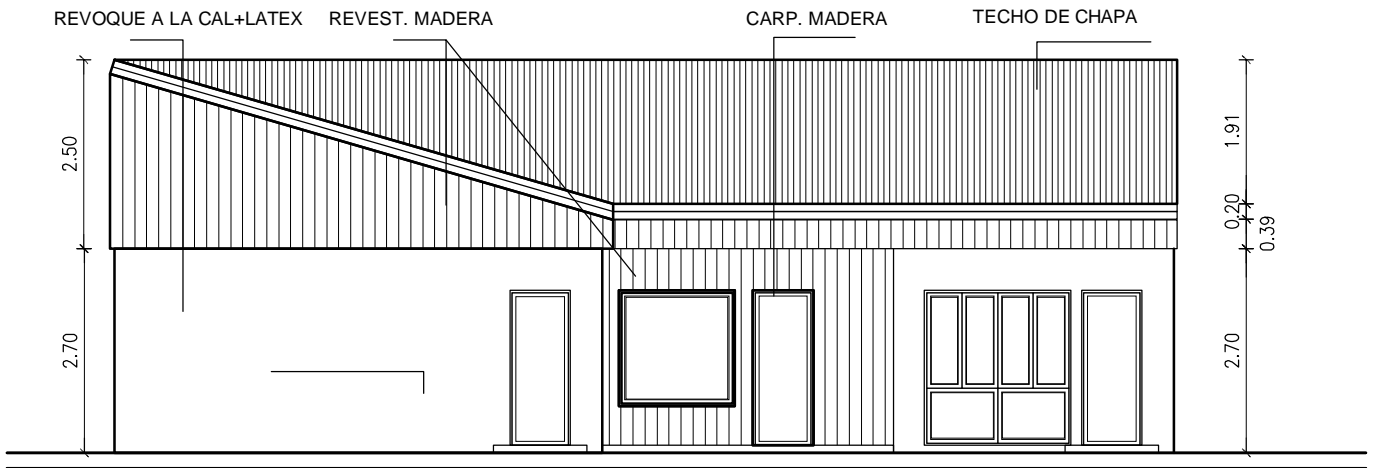

PODER JUDICIAL PROVINCIA DE RIO NEGRO

MANTENIMIENTO INMUEBLES VARIOS-EL BOLSON

PLANO DE: INMUEBLE 1-2 VISTAS

ESCALA: 1:100

02



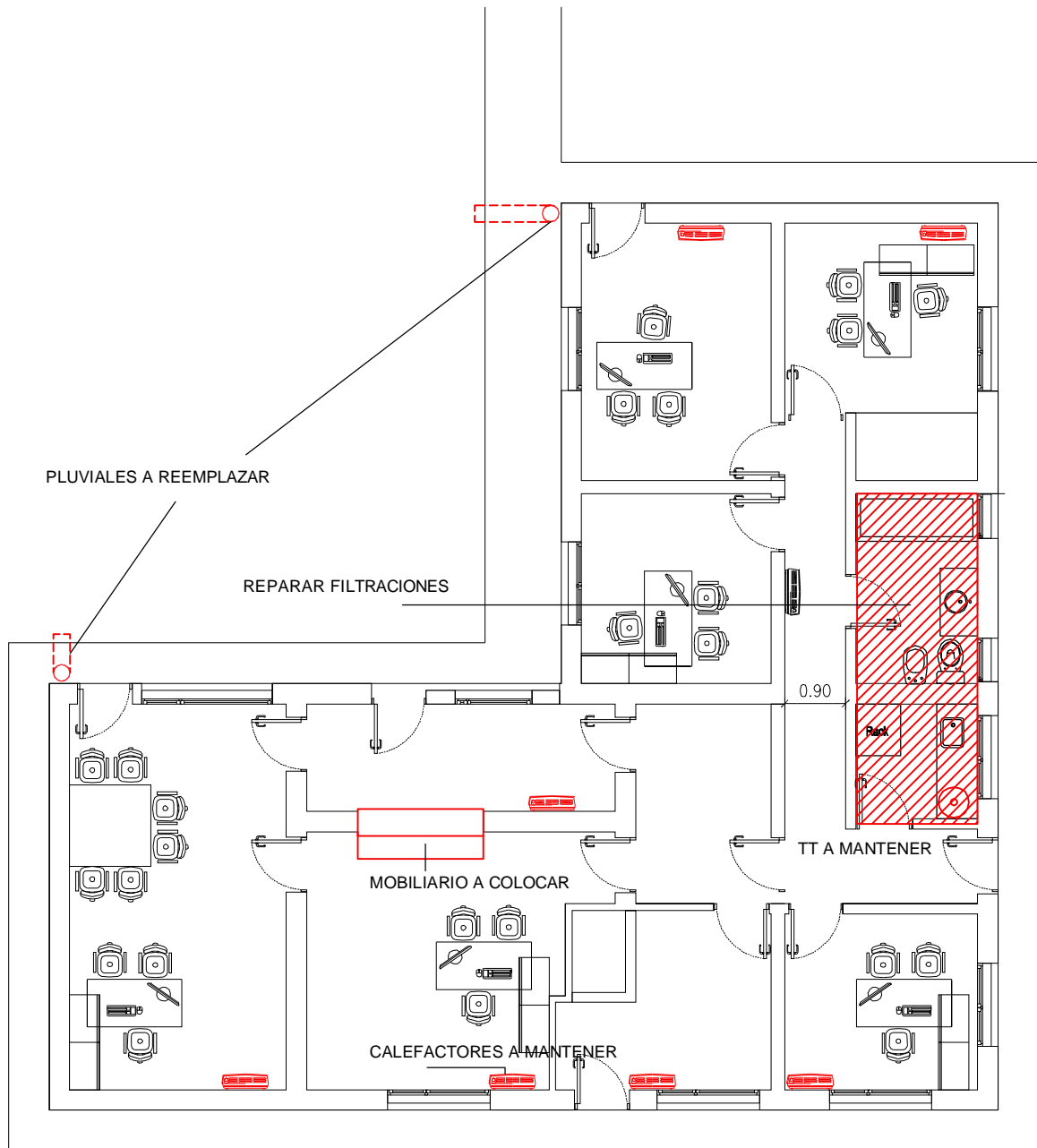

<p>PODER JUDICIAL PROVINCIA DE RIO NEGRO</p>		 <p>PODER JUDICIAL PROVINCIA DE RIO NEGRO</p>
<p>MANTENIMIENTO INMUEBLES VARIOS-EL BOLSON</p>		
<p>PLANO DE: INMUEBLE 1 - INTERVENCION</p>	<p>ESCALA: 1:100</p>	

VENTANA EXISTENTE

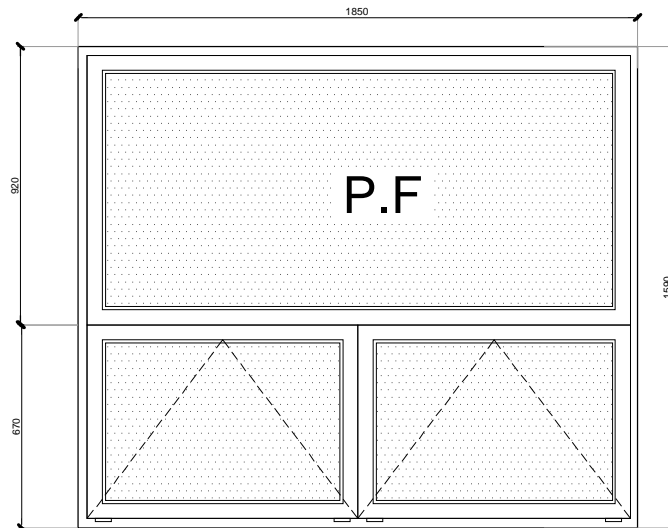

MESA DE ENTRADA A CONSTRUIR - VISTA

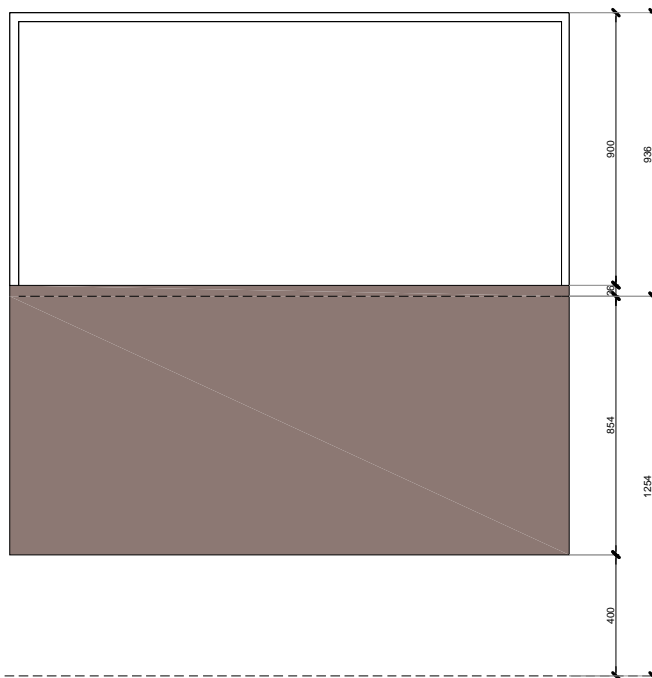

CORTE

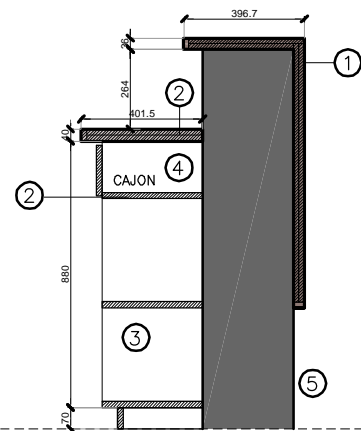

PLANTA

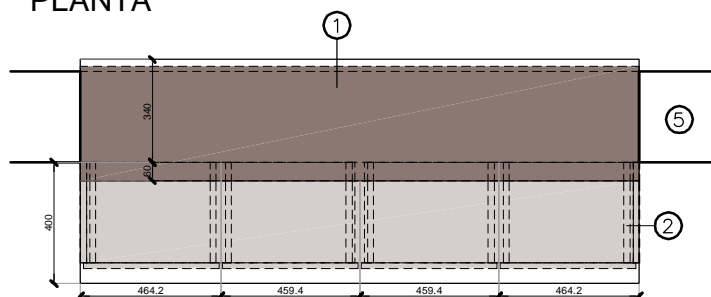

- 1- MELAMINA 18mm COLOR tipo NEBRAZCA.
- 2- MELAMINA 18mm COLOR BLANCA.
- 3- mueble de guardado 2 estantes
- 4- Mueble con cuatro cajoneras
- 5- mamposteria existente

PODER JUDICIAL PROVINCIA DE RIO NEGRO

MANTENIMIENTO INMUEBLES VARIOS-EL BOLSON

PLANO DE: INMUEBLE 1-MOBILIARIO ACCESO

ESCALA: 1:100

04



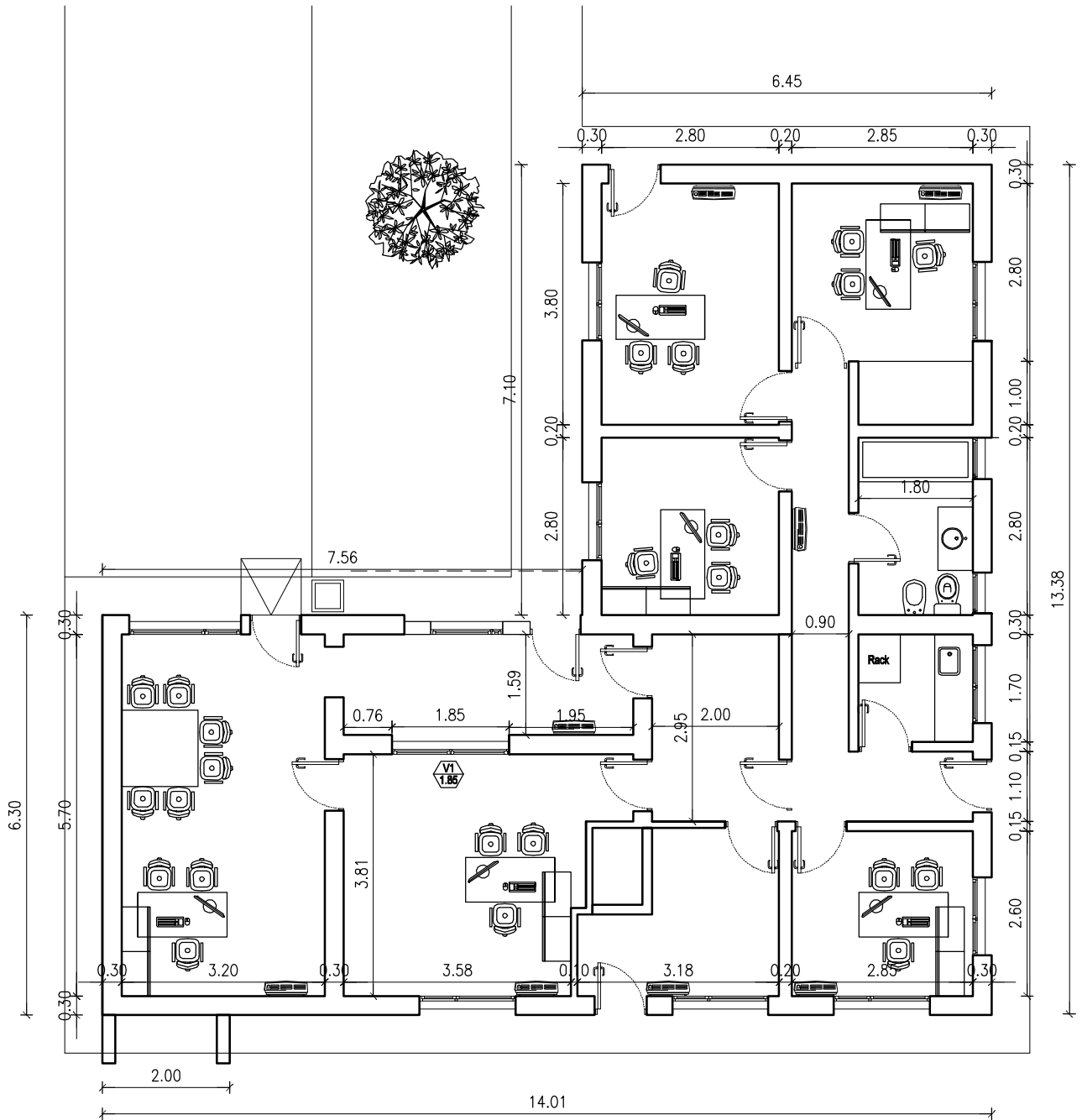

PODER JUDICIAL PROVINCIA DE RIO NEGRO

MANTENIMIENTO INMUEBLES VARIOS-EL BOLSON

PLANO DE: INMUEBLE 2-PLANTA

ESCALA: 1:100

05



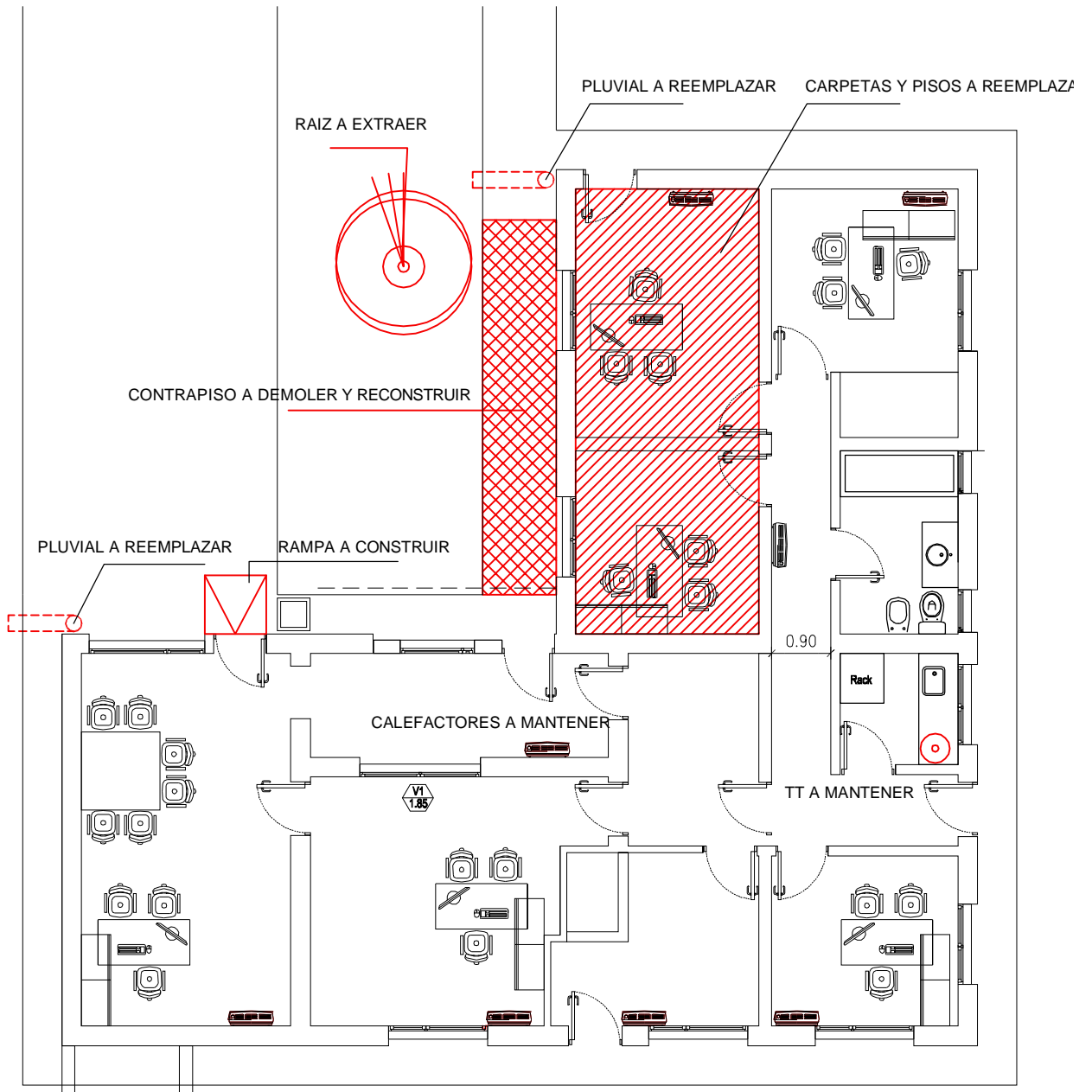

PODER JUDICIAL PROVINCIA DE RIO NEGRO

MANTENIMIENTO INMUEBLES VARIOS-EL BOLSON

PLANO DE: INMUEBLE -INTERVENCION

ESCALA: 1:100

06



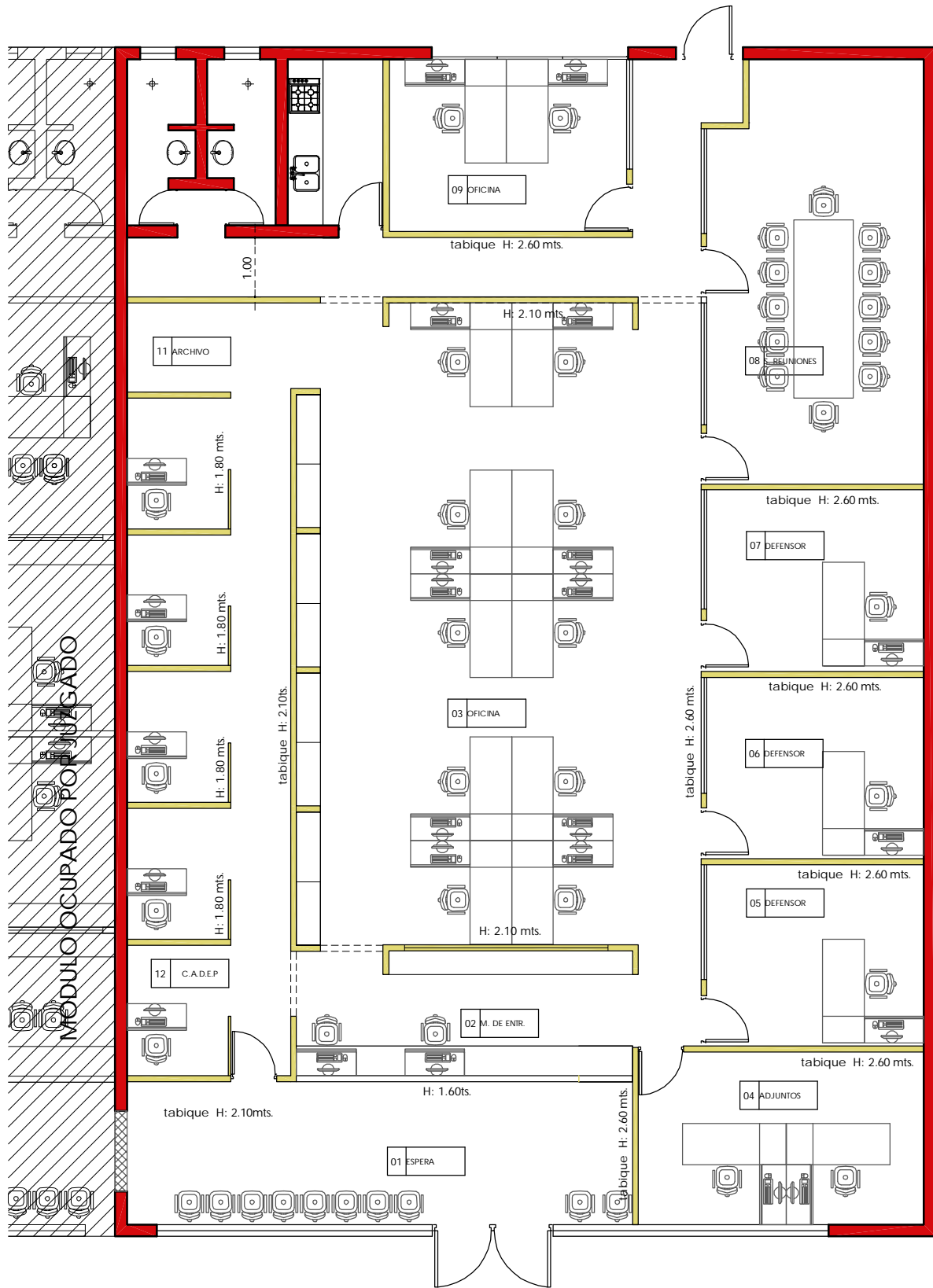

PODER JUDICIAL PROVINCIA DE RIO NEGRO

MANTENIMIENTO INMUEBLES VARIOS-EL BOLSON

PLANO DE: INMUEBLE 3-PLANTA

ESCALA: 1:100



07

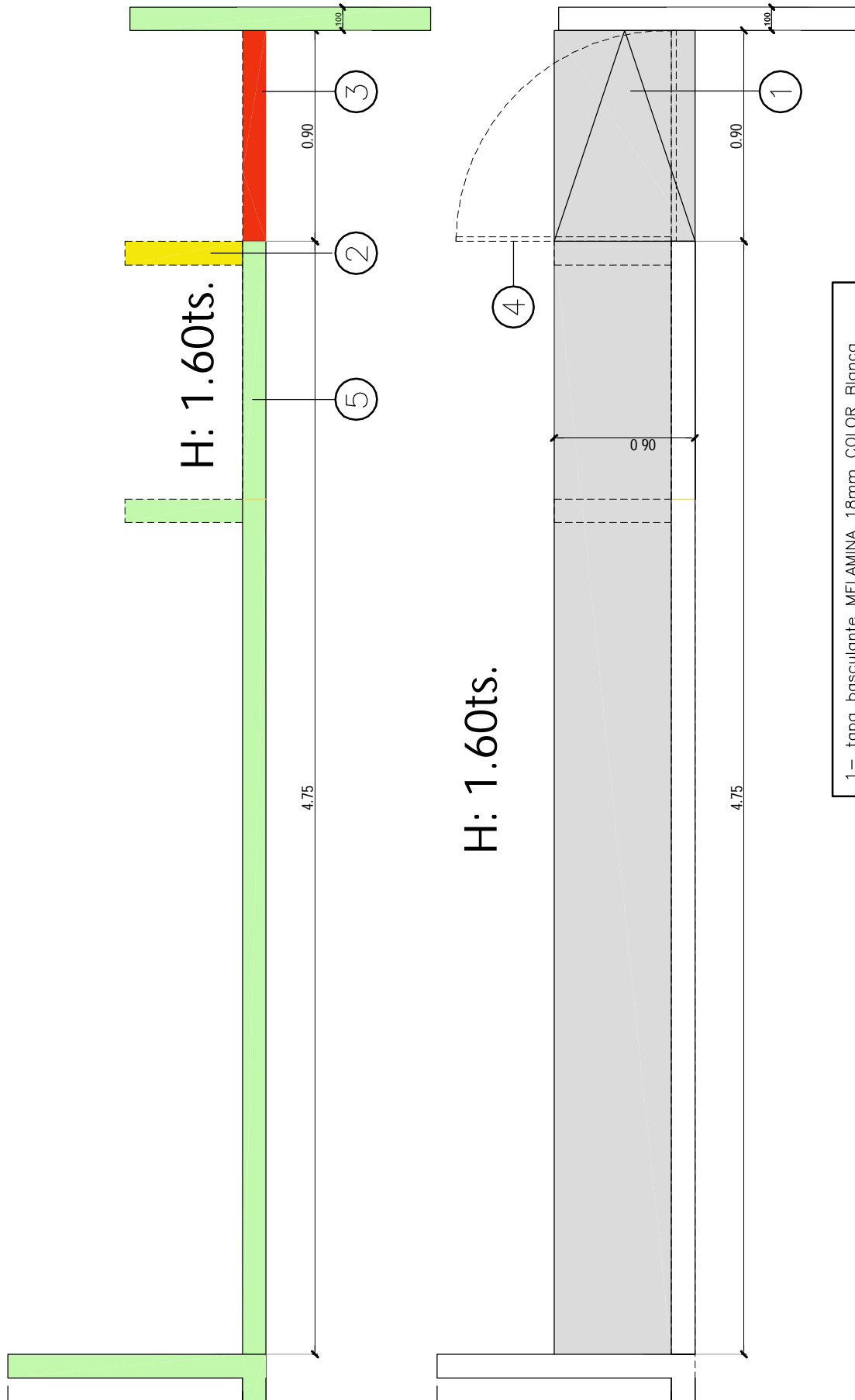

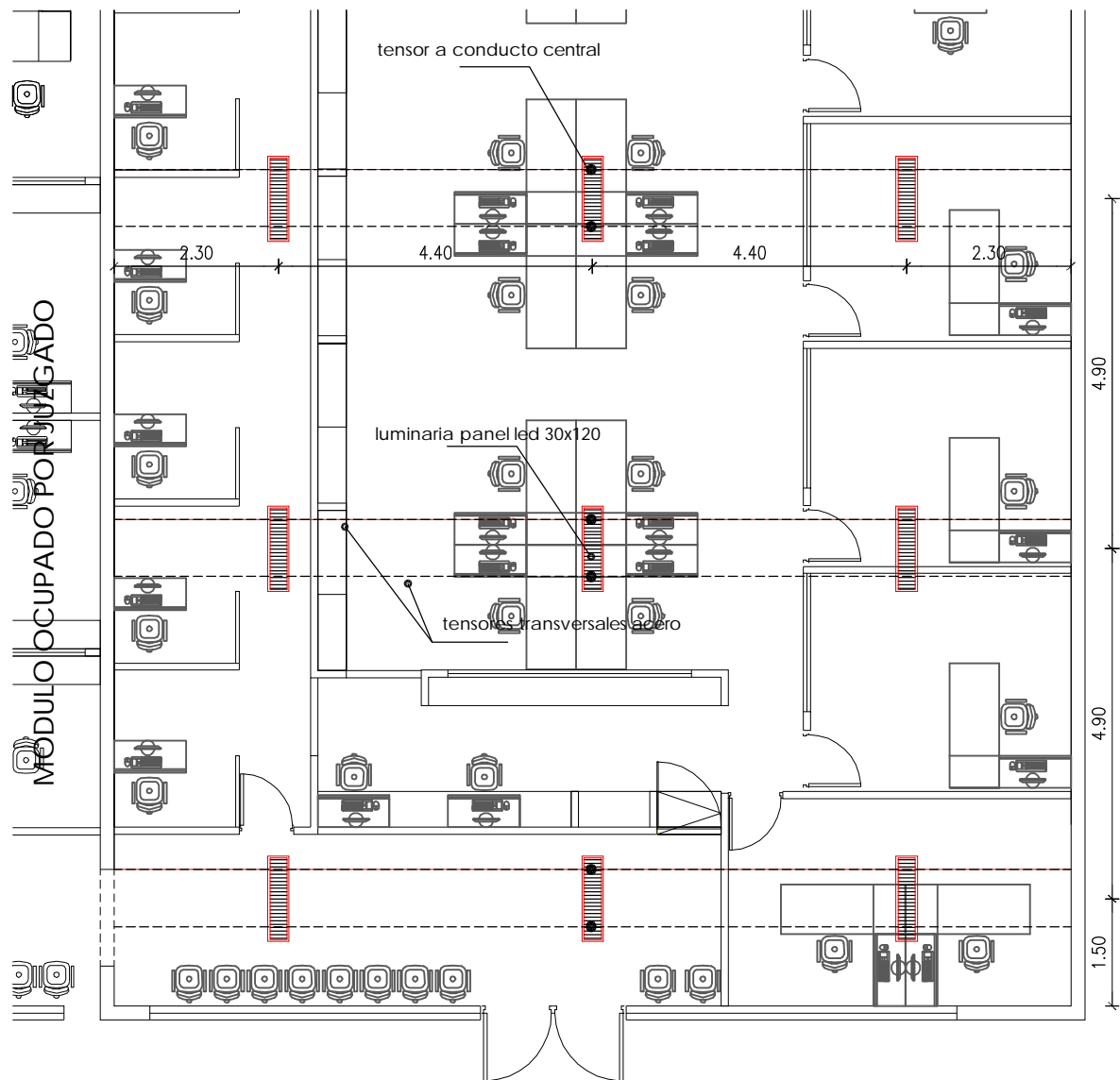

- 1- tapa basculante MELAMINA 18mm COLOR Blanca
- 2- tabique placas de roca de yeso a construir
- 3- tabique placas de roca de yeso a demoler
- 4- placa de abrir MELAMINA 18 mm COLOR BLANCA
- 5- tabique existente



-  luminarias a colocar tipo Lumenac panel led de aplicar 120x30
-  luminarias exteriores reflector tipo lumenac Max 1 - 90 w

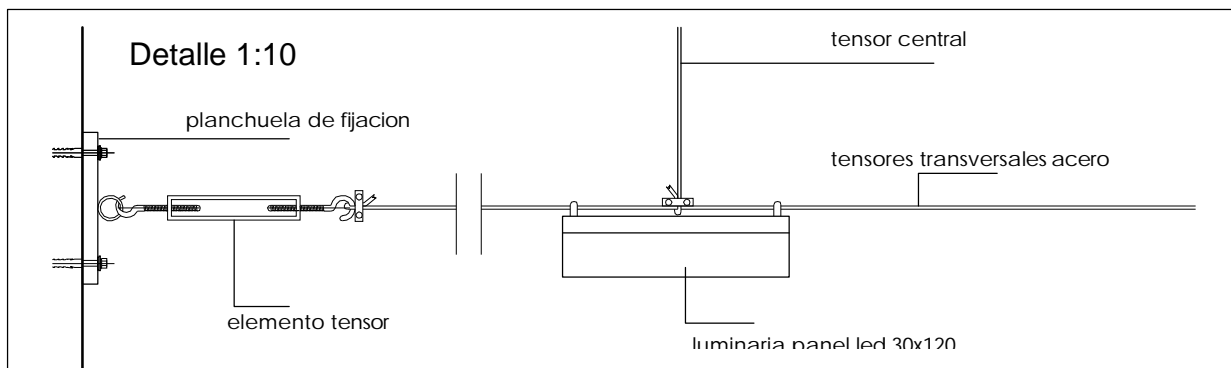

PODER JUDICIAL PROVINCIA DE RIO NEGRO

MANTENIMIENTO INMUEBLES VARIOS-EL BOLSON

PLANO DE: INMUEBLE 3-INST ELECTRICA

ESCALA: 1:100

09

